

Ficha técnica

Lina

Características técnicas

022038 Lina

Estructura opcional



Accionamiento



Motorizado



Automatizado

Instalación



Terraza



Forjado

Detalles técnicos

Vista lateral



Vista superior

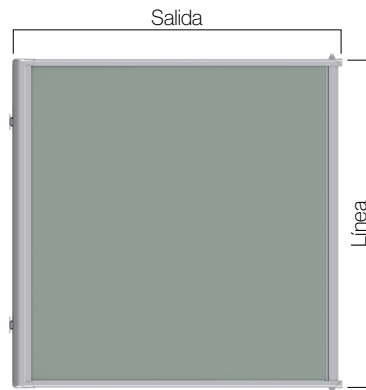

Soportes

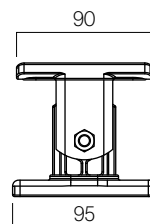
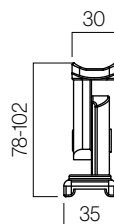
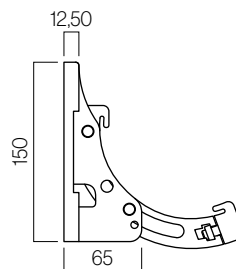
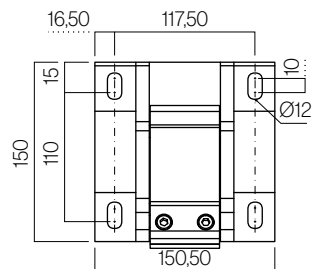
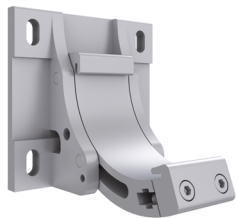

Medidas en mm.

Características técnicas

Con guías y muelle

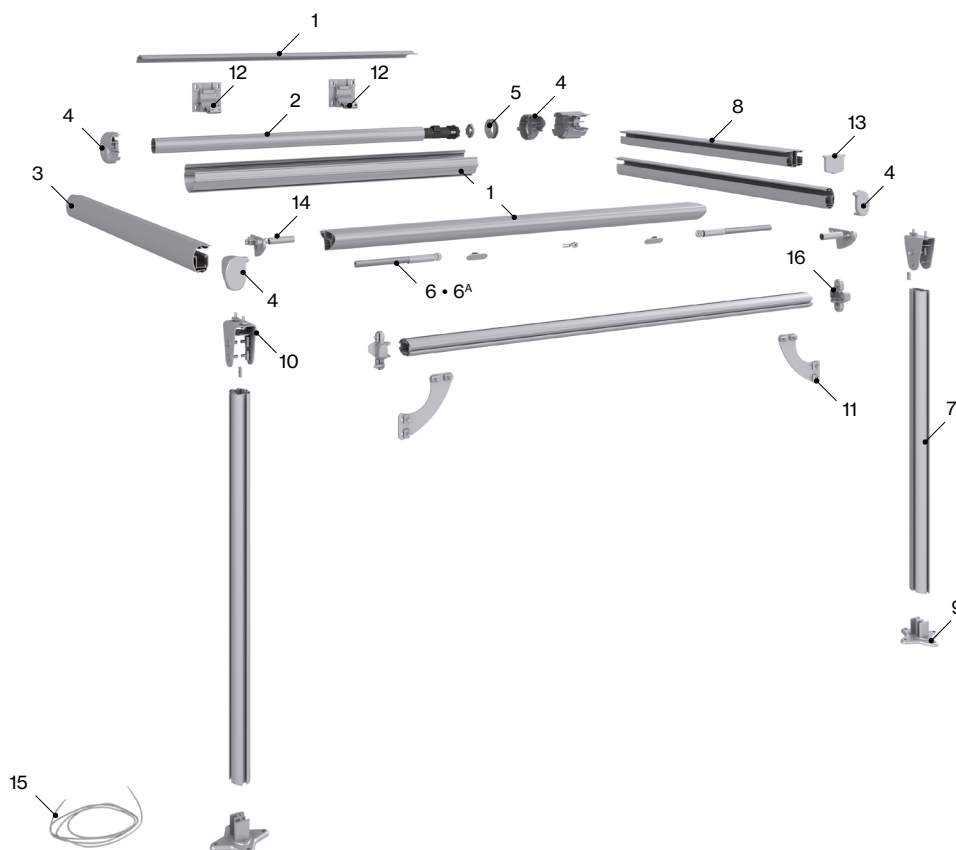

Componentes

Nº	Cód.	Descripción	Nº	Cód.	Descripción
1	022519	Kit perfiles Giotto	9	022752	Pie perfil universal fijación (sólo con estructura)
2	022807	Tubo de enrollamiento ø80	10	022246	Kit unión angular para guía Giotto (sólo con estructura)
3	022508	Perfil guía Giotto	11	022247	Soporte angular Giotto (sólo con estructura)
4	022716	Kit tapas cofre y tapas guía	12	022248	Jgo. soportes a pared Giotto (opcional)
5	022576	Casquillo nylon ø80 hueco ø14 y cojinete	13	022239	Tapón cofre central y tapón guía central Giotto (op.)
6	022734	Muelle tensión ø19 364 mm Giotto	14	022713	Kit de tensión y tapones terminal
6 ^A	022241	Muelle tensión ø19 540 mm Giotto	15	022584	Cuerda de poliéster ø 3 mm
7	022538	Perfil universal fijación (sólo con estructura)	16	022245	Soporte perimetral para guía
8	022240	Guía central Giotto (opcional)			

Resistencia al viento según EN 13561:2004+A1:2008

Salida	Línea																
	2,00	2,25	2,50	2,75	3,00	3,25	3,50	3,75	4,00	4,25	4,50	4,75	5,00	5,25	5,50	5,75	6,00
2,00	1	1	1	1	1	1	1	1	1	1	1	1	1	1	1	1	1
2,25	1	1	1	1	1	1	1	1	1	1	1	1	1	1	1	1	1
2,50	1	1	1	1	1	1	1	1	1	1	1	1	1	1	1	1	1
2,75	1	1	1	1	1	1	1	1	1	1	1	1	1	1	1	1	1
3,00	1	1	1	1	1	1	1	1	1	1	1	1	1	1	1	1	1
3,25	1	1	1	1	1	1	1	1	1	1	1	1	1	1	1	1	1
3,50	1	1	1	1	1	1	1	1	1	1	1	1	1	1	1	1	1
3,75	1	1	1	1	1	1	1	1	1	1	1	1	1	1	1	1	1
4,00	1	1	1	1	1	1	1	1	1	1	1	1	1	1	1	1	1

Clase 1 ≈ 29 Km/h

Tu mundo,
nuestro universo.

— Datasheet

Lina



Technical characteristics

022038 Lina



Mobilisation



Motorized



Automated

Installation possibilities



Terrace



Wrought

Technical details

Side view



Top view

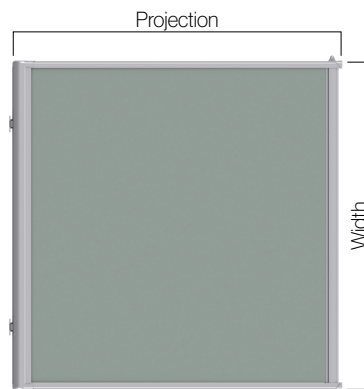

Supports

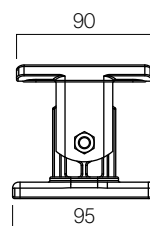
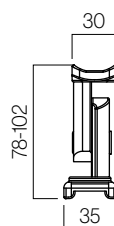
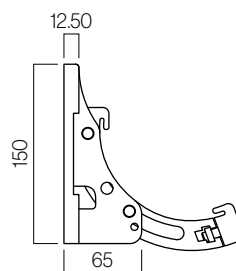
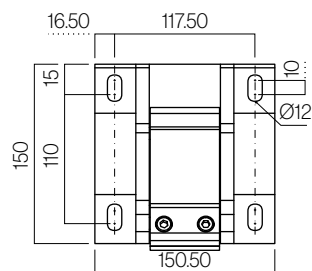
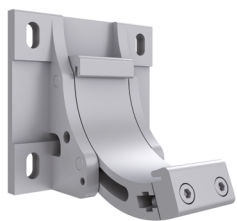

Measurements in mm.

Technical characteristics

With guides and spring

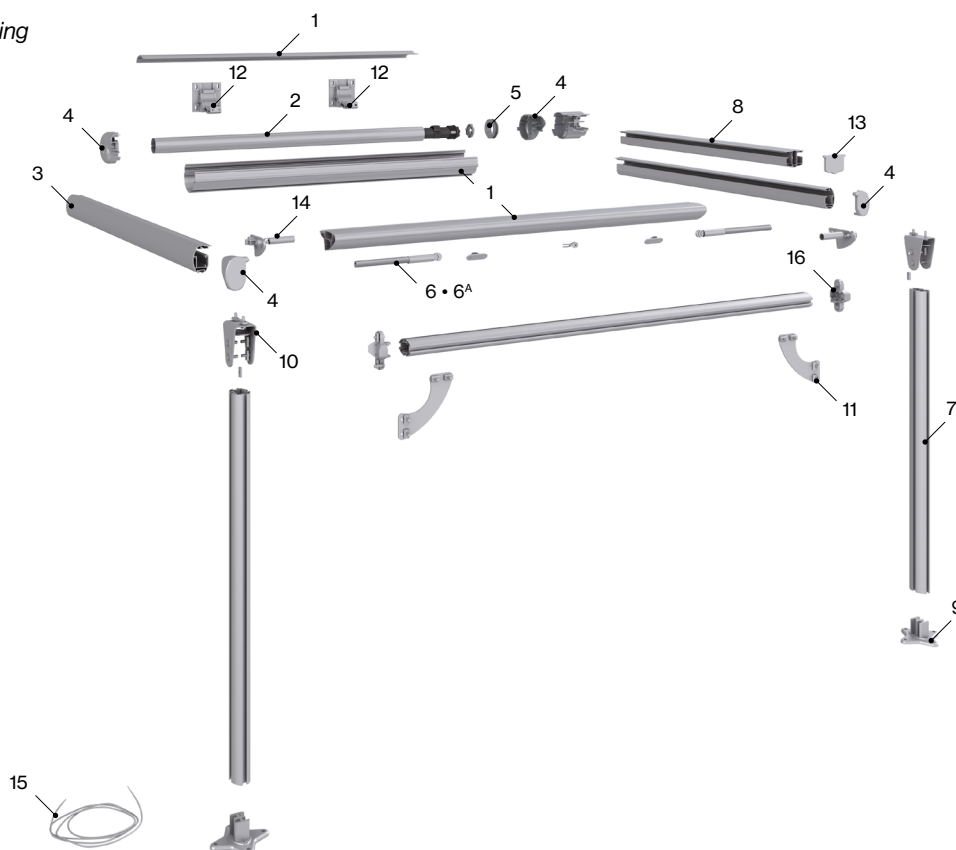

Components

N°	Code	Description	N°	Code	Description
1	022519	Kit of profiles Giotto	9	022752	Fixing profile floor bracket (only with structure)
2	022807	Axle ø80	10	022246	Joint cap set for guide Giotto (only with structure)
3	022508	Guide profile Giotto	11	022247	Angle bracket Giotto (only with structure)
4	022716	Box and guide side caps kit	12	022248	Wall bracket for box Giotto (optional)
5	022576	Nylon round cap ø80 hole ø14 and bearing	13	022239	Central cover and central guide cap Giotto (optional)
6	022734	Tension spring ø19 364 mm Giotto	14	022713	Tension set and terminal caps
6 ^A	022241	Tension spring ø19 540 mm Giotto	15	022584	Polyester strip ø 3 mm
7	022538	Universal profile fixing (only with structure)	16	022245	Perimeter bracket for guide
8	022240	Central guide Giotto (optional)			

Wind resistance EN 13561:2004+A1:2008

Projection	Width																
	2.00	2.25	2.50	2.75	3.00	3.25	3.50	3.75	4.00	4.25	4.50	4.75	5.00	5.25	5.50	5.75	6.00
2.00	1	1	1	1	1	1	1	1	1	1	1	1	1	1	1	1	1
2.25	1	1	1	1	1	1	1	1	1	1	1	1	1	1	1	1	1
2.50	1	1	1	1	1	1	1	1	1	1	1	1	1	1	1	1	1
2.75	1	1	1	1	1	1	1	1	1	1	1	1	1	1	1	1	1
3.00	1	1	1	1	1	1	1	1	1	1	1	1	1	1	1	1	1
3.25	1	1	1	1	1	1	1	1	1	1	1	1	1	1	1	1	1
3.50	1	1	1	1	1	1	1	1	1	1	1	1	1	1	1	1	1
3.75	1	1	1	1	1	1	1	1	1	1	1	1	1	1	1	1	1
4.00	1	1	1	1	1	1	1	1	1	1	1	1	1	1	1	1	1

Clase 1 ≈ 29 Km/h

Your world,
our universe.

— Fiche technique

Lina

Caractéristiques techniques

022038 Lina

Structure en option



Type de manoeuvre



Motorisé



Automatisé

Installation



Terrasse



Forgé

Détails techniques

Vue latérale



Vue supérieure

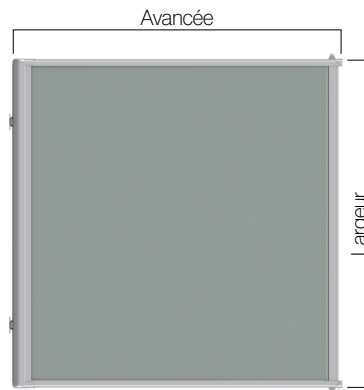

Supports

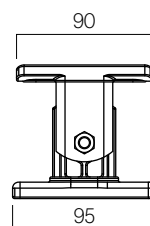
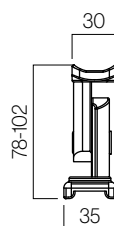
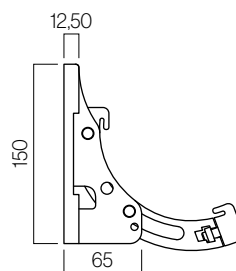
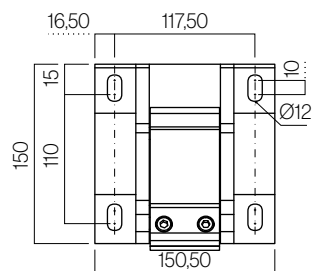
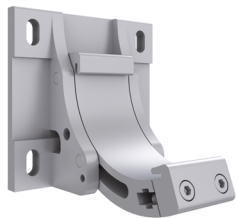

Mesures en mm.

Caractéristiques techniques

Avec coulisses et ressort

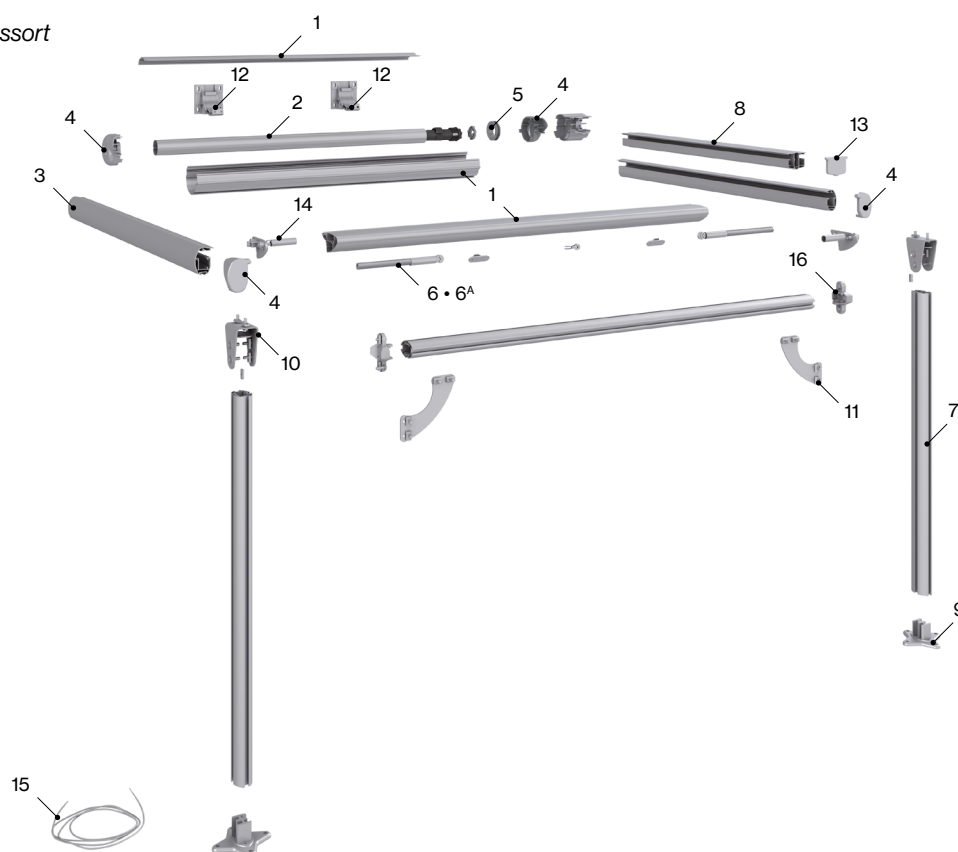

Éléments

N°	Réf.	Description	N°	Réf.	Description
1	022519	Kit profils Giotto	9	022752	Pieds profil universel de fixation (seulem. avec structure)
2	022807	Tube d'enroulement ø80	10	022246	Kit d'union d'angle pour coulisse (seulement avec structure)
3	022508	Profil coulisse Giotto	11	022247	Support angulaire Giotto (seulement avec structure)
4	022716	Kit embouts caisson et coulisses	12	022248	Paire supports a mur Giotto (en option)
5	022576	Embout nylon ø80 creux ø14 avec coussinet	13	022239	Embouts pour caisson et coulisses centrales (en option)
6	022734	Ressort tension ø19 364 mm Giotto	14	022713	Kit de tension et embouts lame finale
6 ^A	022241	Ressort tension ø19 540 mm Giotto	15	022584	Cordon polyester ø 3 mm
7	022538	Profil universonel de fixation (seulement avec structure)	16	022245	Soutien de périmètre pour coulisse
8	022240	Coulisse central Giotto (en option)			

Classement résistance au vent EN 13561:2004+a1:2008

Avancée bras	Largeur																
	2,00	2,25	2,50	2,75	3,00	3,25	3,50	3,75	4,00	4,25	4,50	4,75	5,00	5,25	5,50	5,75	6,00
2,00	1	1	1	1	1	1	1	1	1	1	1	1	1	1	1	1	1
2,25	1	1	1	1	1	1	1	1	1	1	1	1	1	1	1	1	1
2,50	1	1	1	1	1	1	1	1	1	1	1	1	1	1	1	1	1
2,75	1	1	1	1	1	1	1	1	1	1	1	1	1	1	1	1	1
3,00	1	1	1	1	1	1	1	1	1	1	1	1	1	1	1	1	1
3,25	1	1	1	1	1	1	1	1	1	1	1	1	1	1	1	1	1
3,50	1	1	1	1	1	1	1	1	1	1	1	1	1	1	1	1	1
3,75	1	1	1	1	1	1	1	1	1	1	1	1	1	1	1	1	1
4,00	1	1	1	1	1	1	1	1	1	1	1	1	1	1	1	1	1

Classe 1 ≈ 29 Km/h

Votre monde,
notre univers.

— Scheda tecniche

Lina

Caratteristiche tecniche

022038 Lina

Struttura opzionale



Azionamento

 Motorizzato

 Automatizzato

Installazione

 Terrazzo

 Forjado

Dettagli tecnici

Vista laterale



Vista superiore

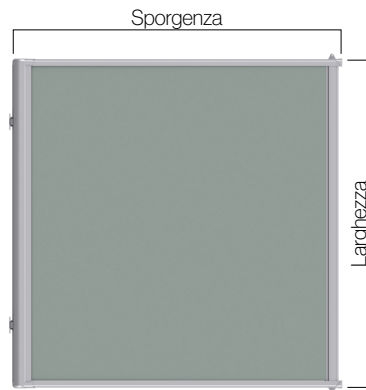

Supporti

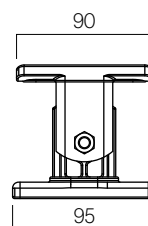
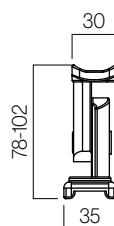
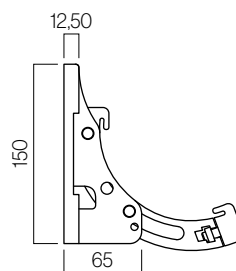
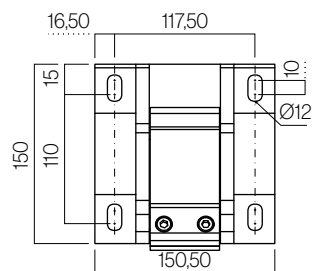
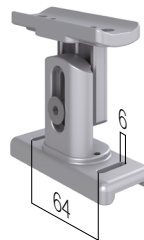

Misure in mm.

Caratteristiche tecniche

Con guías y muelle

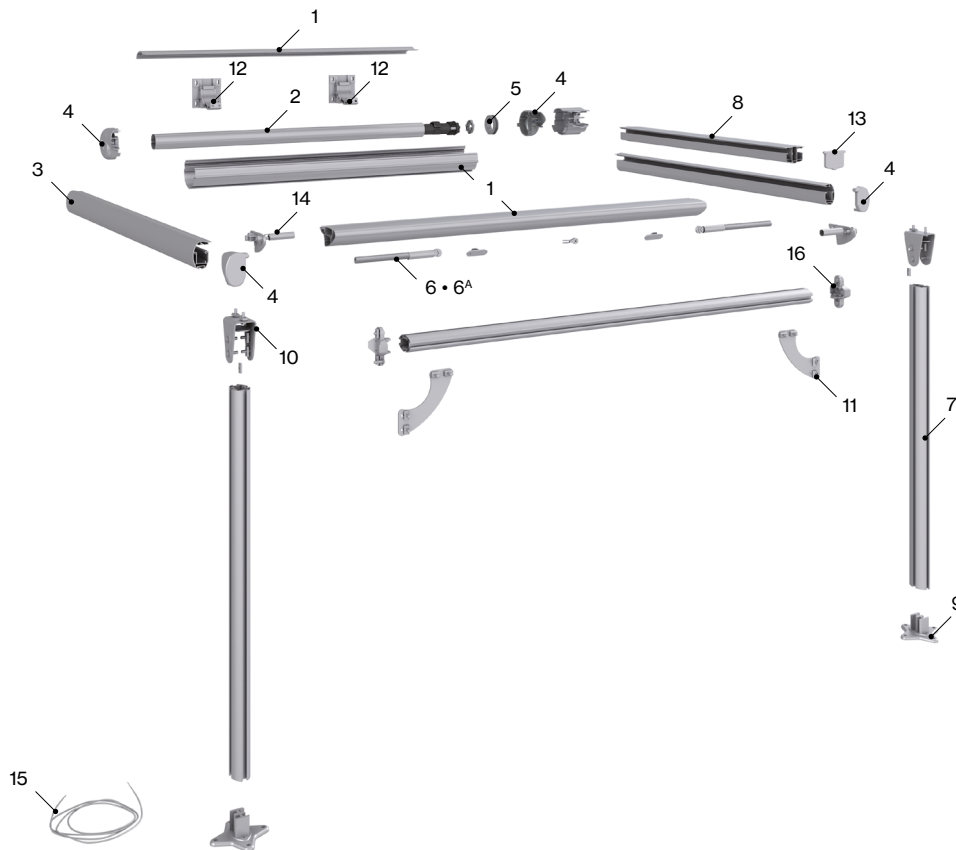

Componenti

Nº	Codice	Descrizione	Nº	Codice	Descrizione
1	022519	Kit profili	9	022752	Supporto pavimento (solo con struttura)
2	022807	Rullo di avvolgimento ø80	10	022246	Kit si unione angolare per guida (solo con struttura)
3	022508	Profilo guida Giotto	11	022247	Supporto angolare (solo con struttura)
4	022716	Kit tappi cassonetto e guida	12	022248	Coppia supporti a muro (opzionale)
5	022576	Calotta nylon ø80 cavo ø14 e cuscinetto	13	022239	Tappo cassonetto centrale e guida centrale (op.)
6	022734	Molla di tensione ø19 364 mm	14	022713	Kit di tensione e tappi terminale
6 ^A	022241	Molla di tensione ø19 540 mm	15	022584	Corda in poliester e ø3 mm
7	022538	Profilo universale fissaggio (solo con struttura)	16	022245	Supporto perimetrale per guida
8	022240	Guida centrale (opzionale)			

Resistenza al vento EN 13561:2004+A1:2008

Sporgenza bracci	Larghezza																
	2,00	2,25	2,50	2,75	3,00	3,25	3,50	3,75	4,00	4,25	4,50	4,75	5,00	5,25	5,50	5,75	6,00
2,00	1	1	1	1	1	1	1	1	1	1	1	1	1	1	1	1	1
2,25	1	1	1	1	1	1	1	1	1	1	1	1	1	1	1	1	1
2,50	1	1	1	1	1	1	1	1	1	1	1	1	1	1	1	1	1
2,75	1	1	1	1	1	1	1	1	1	1	1	1	1	1	1	1	1
3,00	1	1	1	1	1	1	1	1	1	1	1	1	1	1	1	1	1
3,25	1	1	1	1	1	1	1	1	1	1	1	1	1	1	1	1	1
3,50	1	1	1	1	1	1	1	1	1	1	1	1	1	1	1	1	1
3,75	1	1	1	1	1	1	1	1	1	1	1	1	1	1	1	1	1
4,00	1	1	1	1	1	1	1	1	1	1	1	1	1	1	1	1	1

Classi 1 ≈ 29 Km/h

Il tuo mondo,
il nostro universo.

Folha técnica

Lina

Características técnicas

022038 Lina

Estrutura opcional



Accionamento



Motorizado



Automatizado

Instalação



Terraço



Forjado

Detalhes técnicos

Vista lateral



Vista superior

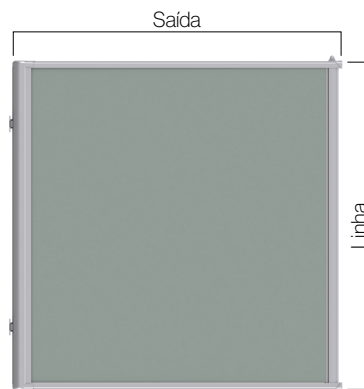

Suportes

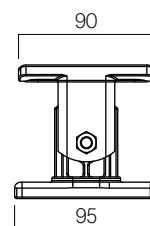
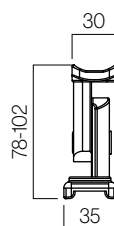
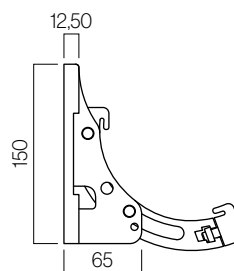
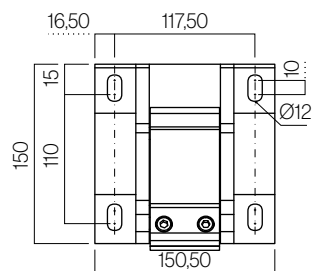
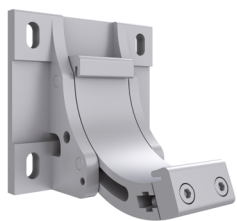

Medidas em mm.

Características técnicas

Com guias e mola

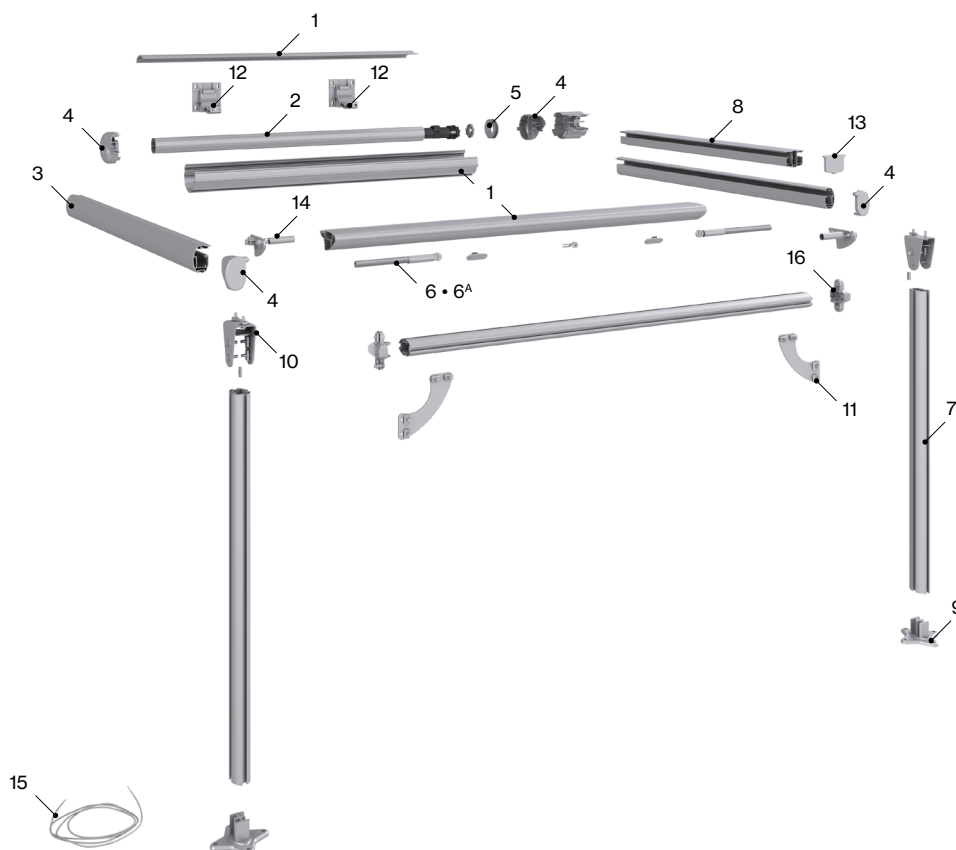

Componentes

Nº	Cód.	Descrição	Nº	Cód.	Descrição
1	022519	Kit perfis Giotto	9	022752	Base perfil de fixação universal (apenas com estrutura)
2	022807	Tubo de enrolamento Ø80	10	022246	Kit de conectores angulares para guia (apenas com estrut.)
3	022508	Perfil guia Giotto	11	022247	Apoio angular Giotto (só com estrutura)
4	022716	Kit tampas cassete e tampas de guia	12	022248	Conj. suportes de parede Giotto (opcional)
5	022576	Bucha de nylon ø80 oco ø14 e rolamento	13	022239	Tampa cassete central e tampa guia central Giotto (op)
6	022734	Mola de tensão ø19 364 mm Giotto	14	022713	Kit de tensão e tampões de terminais
6 ^A	022241	Mola de tensão ø19 540 mm Giotto	15	022584	Corda de poliéster ø 3 mm
7	022538	Perfil de fixação universal (apenas com estrutura)	16	022245	Suporte perimetral para guia
8	022240	Guia central Giotto (opcional)			

Classificação ao vento EN 13561:2004+A1:2008

Altura	Largura																
	2,00	2,25	2,50	2,75	3,00	3,25	3,50	3,75	4,00	4,25	4,50	4,75	5,00	5,25	5,50	5,75	6,00
2,00	1	1	1	1	1	1	1	1	1	1	1	1	1	1	1	1	1
2,25	1	1	1	1	1	1	1	1	1	1	1	1	1	1	1	1	1
2,50	1	1	1	1	1	1	1	1	1	1	1	1	1	1	1	1	1
2,75	1	1	1	1	1	1	1	1	1	1	1	1	1	1	1	1	1
3,00	1	1	1	1	1	1	1	1	1	1	1	1	1	1	1	1	1
3,25	1	1	1	1	1	1	1	1	1	1	1	1	1	1	1	1	1
3,50	1	1	1	1	1	1	1	1	1	1	1	1	1	1	1	1	1
3,75	1	1	1	1	1	1	1	1	1	1	1	1	1	1	1	1	1
4,00	1	1	1	1	1	1	1	1	1	1	1	1	1	1	1	1	1

Classe 1 ≈ 29 Km/h

O seu mundo,
o nosso universo.