

— Ficha técnica

Plegable y Pacchetto



Modelos

Plegable y Pacchetto

038042 Plegable

038061 Pacchetto



Componentes

Nº	Cód.	Descripción	Nº	Cód.	Descripción
1	030329	Pletina fibra de vidrio	6	028031	Cabezal aluminio
2	030425	Tensor Slim L	7	028035	Recogedor cordón Plus
3	040083	Aro de cadena 1,50	8	028034	Tapadera Plus
4	028033	Comando Plus	9	030291	Soporte techo/pared Plus
5	030242	Soporte techo	10	038109	Varilla fibra de vidrio

Medidas de fabricación

Máximos		Mínimos	
Ancho	2,50 m	Ancho	0,40 m
Alto	3,00 m	Alto	0,50 m

Características técnicas

Modelos

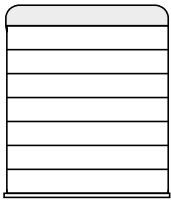

Plegable

Con varillas horizontales y terminal de aluminio.
Estándar

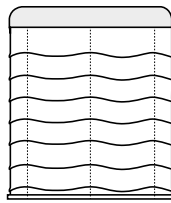

Pacchetto

Sin varillas, con cintas verticales y terminal de aluminio.

Perfiles

Sistema plus

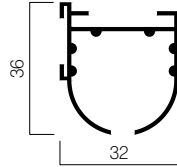

Detalles a tener en cuenta por el instalador

Estéticamente, una instalación con dos o más cortinas Plegables, queda mejor si coinciden las varillas, para ello, deben indicarnos esta particularidad al pasar el pedido, si no lo indican coincidirán niveladas por abajo.

Nivel según cortina

Mismo alto

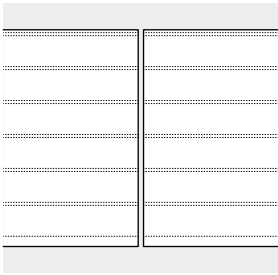

Altos distintos

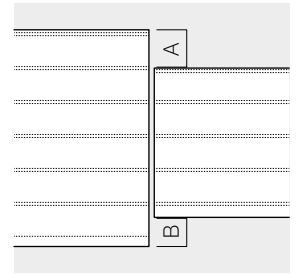
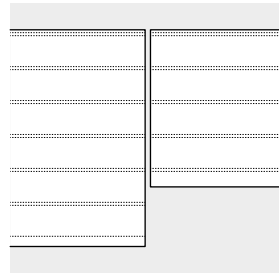
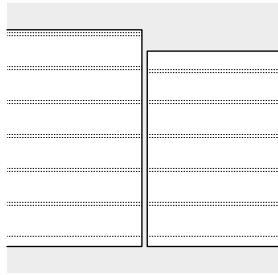

Accesorios

Escuadra de 10 cm
034048

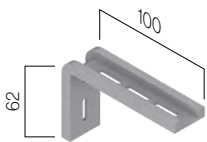

Escuadra de 14 cm
034049

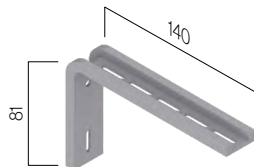

Escuadra de 21 cm
034052

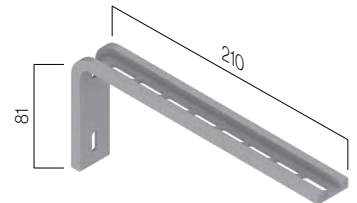

Tu mundo,
nuestro universo.

F.T. PLEGABLE Y PACCHETTO · ES · 01 · 0422

— Datasheet

Roman Blind and Pacchetto



Models

Roman blind and Pacchetto

038042 Roman blind

038061 Pacchetto

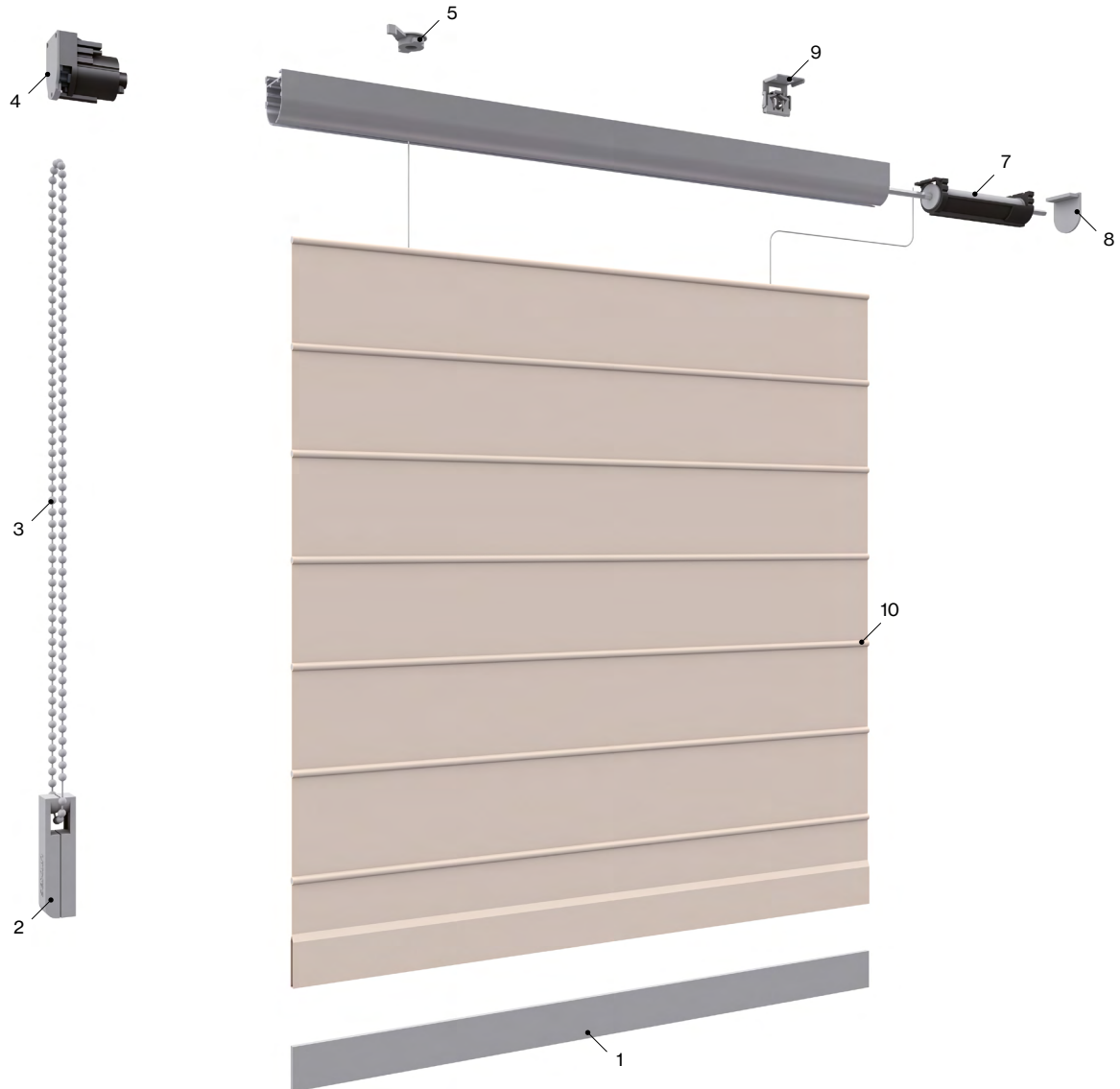

Components

Nº	Code	Description	Nº	Code	Description
1	030329	Fiberglass plate	6	028031	Aluminium head
2	030425	Slim L Tensor	7	028035	Plus Cord Collector
3	040083	Chain ring 1.50	8	028034	Plus Lid
4	028033	Command Plus	9	030291	Plus ceiling/wall bracket
5	030242	Ceiling bracket	10	038109	Fiberglass rod

Manufacturing measurements

Maximum		Minimum	
Width	2.50 m	Width	0.40 m
Height	3.00 m	Height	0.50 m

Technical characteristics

Models

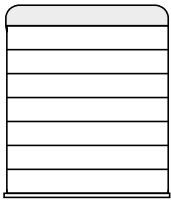

Roman blind

With horizontal rods
and aluminium end slat.
Standard

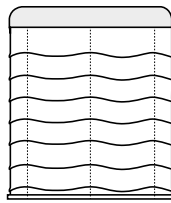

Pacchetto

Without rods, with vertical
tapes and aluminium end
slat.

Profiles

System plus

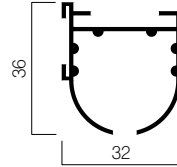

Details to be taken into account by the installer

In an installation with two or more Folding curtains it is aesthetically better for the rods to overlap. This feature must be requested when making the order, otherwise they will be levelled down.

Second curtain level

Same height

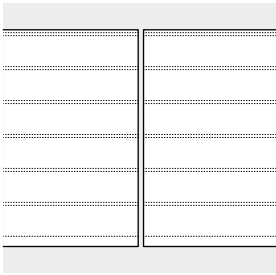

Different height

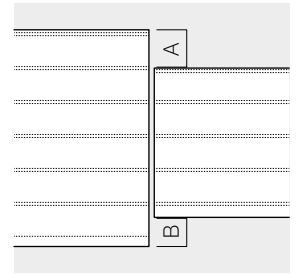
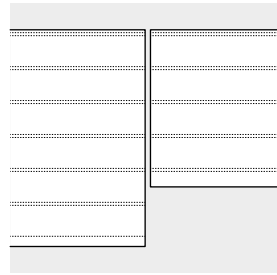
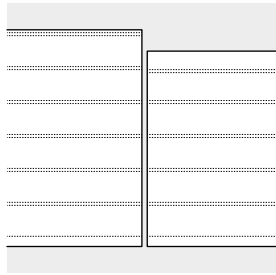

Accessories

Square 10 cm
034048

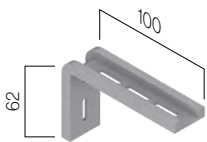

Square 14 cm
034049

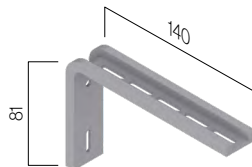

Square 21 cm
034052

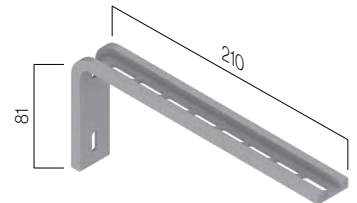

Your world,
our universe.

F.T. PLEGABLE Y PACCHETTO · EN · 01 · 0422

— Fiche technique

Pliable et Pacchetto



 Modèle

Pliable et Pacchetto

038042 Pliable

038061 Pacchetto



Éléments

N°	Réf.	Description	N°	Réf.	Description
1	030329	Platine fibre de verre	6	028031	Profil aluminium
2	030425	Contrepoids chaîne Slim L	7	028035	Enrouleur cordon Plus
3	040083	Chaîne 1,50	8	028034	Embout Plus
4	028033	Commande Plus	9	030291	Support plafond/mur Plus
5	030242	Support plafond	10	038109	Baguette fibre de verre

Mesures de fabrication

Maximums		Minimums	
Largeur	2,50 m	Largeur	0,40 m
Hauteur	3,00 m	Hauteur	0,50 m

Caractéristiques techniques

Modèles

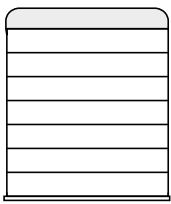

Pliable

Avec des baguettes horizontales et lame finale en aluminium.
Estándar

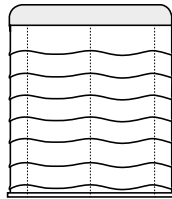

Pacchetto

Sans baguettes, avec bandes verticales et lame finale aluminium.

Profils

Système plus

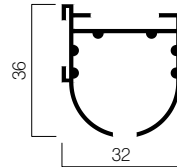

Détails à prendre en compte pour l'installation

Afin de privilégier l'esthétisme du produit, lors de la pose de plusieurs rideaux côte à côte veuillez nous l'indiquer sur votre commande (4 options en dessin). Sans indication de condition les rideaux sont alignés par la baguette inférieur.

Niveau du second rideau

Même hauteur

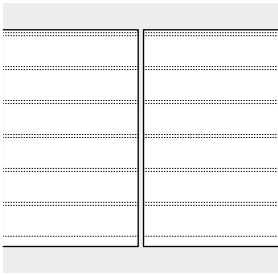

Hauteur différente

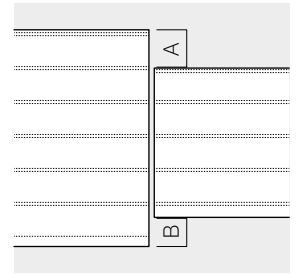
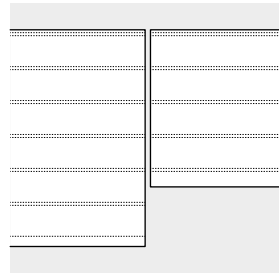
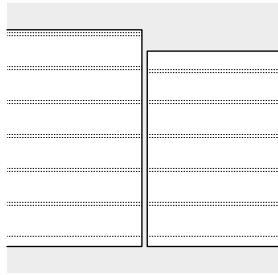

Accessoires

Équerre de 10 cm
034048

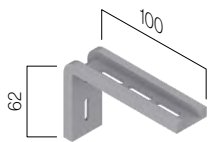

Équerre de 14 cm
034049

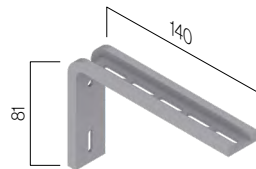

Équerre de 21 cm
034052

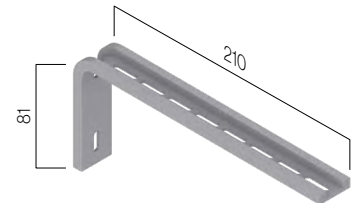

Tu mundo,
nuestro universo.

F.T. PLEGABLE Y PACCHETTO · ES · 01 · 0422

— Scheda tecniche

Pieghevole e Pacchetto



Pieghevole e Pacchetto

038042 Pieghevole

038061 Pacchetto



Componenti

N°	Codice	Descrizione	N°	Codice	Descrizione
1	030329	Piastra in fibra di vetro	6	028031	Cassonetto in alluminio
2	030425	Tenditore Slim L	7	028035	Collettore corda Plus
3	040083	Anello catena 1,50	8	028034	Coperchio Plus
4	028033	Comando Plus	9	030291	Staffa a parete/soffitto Plus
5	030242	Supporto per il soffitto	10	038109	Asta in fibra di vetro

Misure di produzione

Massimo		Minimo	
Larghezza	2,50 m	Larghezza	0,40 m
Altezza	3,00 m	Altezza	0,50 m

Caratteristiche tecniche

Modelli

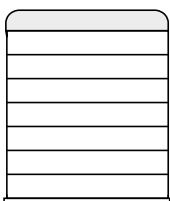

Pieghevole

Con aste orizzontali e terminale in alluminio.
Standard

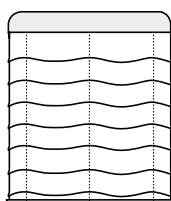

Pacchetto

Senza aste, con cintini verticali e terminale in alluminio.

Profili

Sistema plus

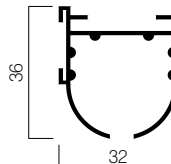

Dettagli che devono essere presi in considerazione dall'installatore

Esteticamente, un'installazione con due o più tende pieghevoli, rappresentano la soluzione migliore nel caso in cui le aste coincidano. Per questo motivo, vi preghiamo di indicarci tale particolarità nel momento dell'esecuzione dell'ordine. Qualora non vengano specificate saranno livellate dal basso.

Livello seconda tenda

Stessa altezza

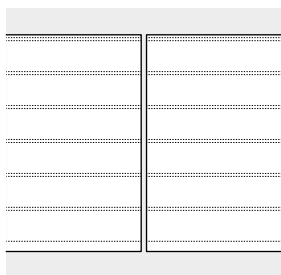

Diverse altezze

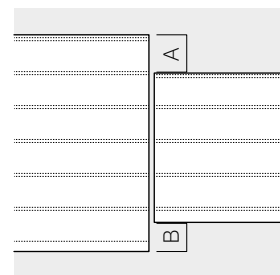
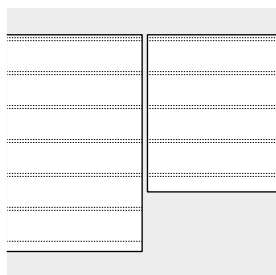
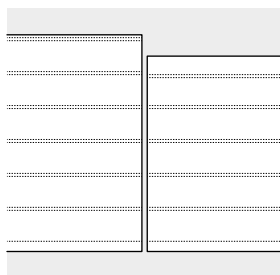

Accessori

Staffa de 10 cm
034048

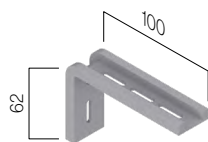

Staffa de 14 cm
034049

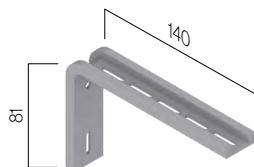

Staffa de 21 cm
034052

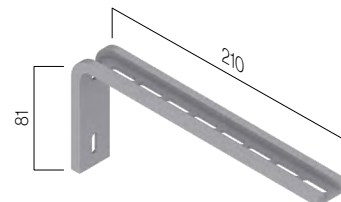

Il tuo mondo,
il nostro universo.

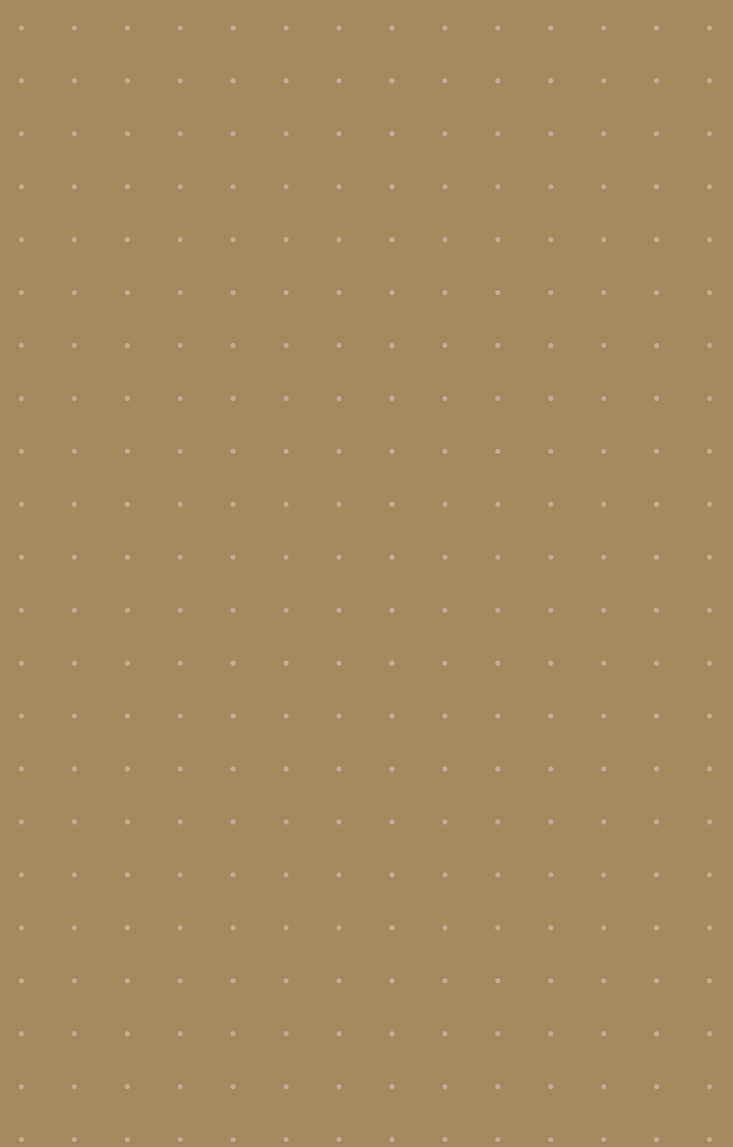

— Folha técnica

Dobrável e Pacchetto

Modelos

Dobrável e Pacchetto

038042 Dobrável
038061 Pacchetto



Componentes

Nº	Cód.	Descrição	Nº	Cód.	Descrição
1	030329	Placa de fibra de vidro	6	028031	Cabeça alumínio
2	030425	Tensor Slim L	7	028035	Coletor de cabo Plus
3	040083	Aro de corrente 1,50	8	028034	Placa de cobertura Plus
4	028033	Comando Plus	9	030291	Suporte teto/parede Plus
5	030242	Suporte teto	10	038109	Vareta fibra de vidro

Medidas de fabricação

Máximos		Mínimos	
Largura	2,50 m	Largura	0,40 m
Altura	3,00 m	Altura	0,50 m

Características técnicas

Modelos

Perfis

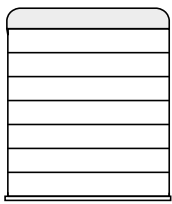

Dobrável

Com varetas horizontais e terminal de alumínio.
PADRÃO

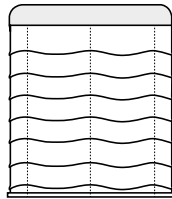

Pacchetto

Sem varetas, com faixas verticais e terminal de alumínio.

Sistema plus

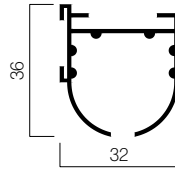

Detalhes a serem tidos em conta pelo instalador

Esteticamente, uma instalação com duas ou mais cortinas dobráveis fica melhor se as varetas forem iguais; para isso, deve indicar-nos esta particularidade ao fazer a encomenda, pois serão niveladas por baixo se não o referir.

Nível segunda cortina

Mesma altura

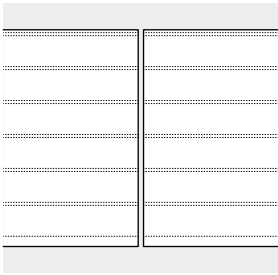

Alturas diferentes

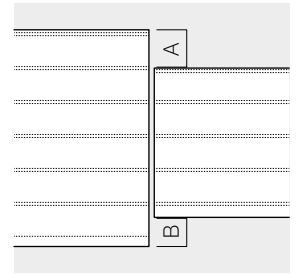
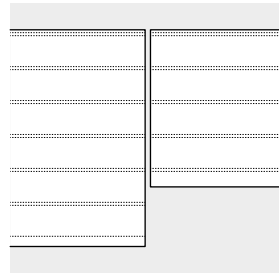
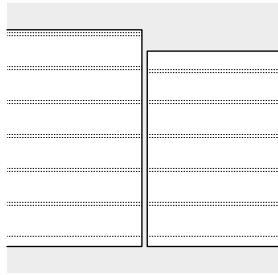

Accessórios

Esquadro de 10 cm
034048

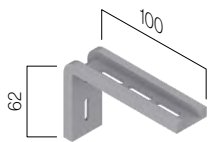

Esquadro de 14 cm
034049

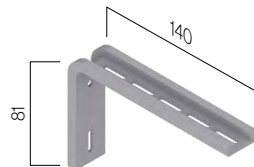

Esquadro de 21 cm
034052

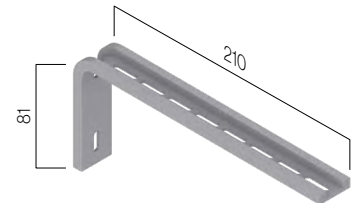

O seu mundo,
o nosso universo.

